

Input/Data Acquisition System Design for Human Computer Interfacing

William Putnam and R. Benjamin Knapp

Copyright (c) 1996 William Putnam and R. Benjamin Knapp. Permission to make digital or hard copies of part or all of this work for personal or classroom use is granted without fee provided that copies are not made or distributed for profit or commercial advantage and that copies bear this notice and full citation on the first page. To copy otherwise, to republish, to post on services, or to redistribute to lists, requires specific permission and/or a fee.

October 17, 1996

1 Introduction

In this course we have divided the Human Computer Interface (HCI) into three parts: the input/data acquisition, the computer recognition and processing, and the output/display (see Figure 1). These set of notes describe in detail the first component, the input/data acquisition, i.e., the way in which information about the user is conveyed to the computer.



Figure 1: The Human Computer Interface Structure

2 General Overview

Figure 2 shows how information from the human is passed to the computer. It separates the process into three parts: sensors, signal conditioning, and data acquisition. The choices made in the design of these systems ultimately determines how intuitive, appropriate, and reliable the interaction is between human and computer.

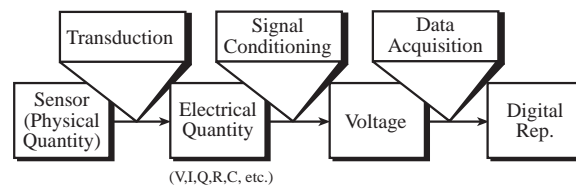

Figure 2: The Path from Human to Computer

2.1 The Sensor

One approach to choosing an appropriate sensor would be to model computer sensing after the five human senses: gustatory (taste), olfactory (smell), tactile, auditory, and visual. The better approach, however, is to decide what volitional (or even non-volitional) actions of the user will be important for the particular computer application. In other words, it is important to decide what gestures by the human are appropriate for the application and determine what sensor is optimal in measuring that gesture. Before determining what computer inputs to use we must determine what human outputs are appropriate. For example, say we would like to use the tension in the forearm as a way of telling the computer to pick up a virtual (or real) coffee cup. We would then incorporate into our HCI a sensor that could pick up the electrical signal from the muscle of the forearm (this will be discussed in section 3.4 below). If we had patterned computer senses solely after human senses, this would not be possible.

Sensors can be categorized in many ways. They can be categorized by the underlying physics of their operation. However, one physical principle can be used to measure many different phenomena. For example, the piezoelectric effect can measure force, flexure, acceleration, heat, and acoustic vibrations. Sensors can be categorized by the particular phenomenon they measure. However, one phenomenon can be measured by many physical principles. For example, sound waves can be measured by the piezoelectric effect, capacitance, electromagnetic field effects, and changes in resistance. Sensors can also be grouped by a particular application. For example, one could group all sensors together that can be used to measure distance. However, since there is a clever way to use almost any sensor to measure distance, this is not necessarily a good way to analyze sensors either.

With no method of categorization being clearly superior to any other, the authors arbitrarily chose to discuss sensors according to their underlying physical principles. Section 3 will give an overview of many different sensors, the physical properties by which they operate, and the actions that they measure. In reading this section, keep in mind what is the sensitivity of the sensor, what inaccuracies could occur in using it to sense gestures, and what are the properties of the signal that will be generated by the sensor (e.g., temporal structure, spectrum, statistics, and dynamic range).

2.2 Signal Conditioning

After the information about the user is measured by a sensor, it must be changed to a form appropriate for input into the data acquisition system. In most applications this means changing the sensors output to a voltage (if it isn't already), modifying the sensors dynamic range to maximize the accuracy of the data acquisition system, removing unwanted signals, and limiting the sensor's spectrum. Additionally, analog signal processing (both linear and nonlinear) may be desired to alleviate processing load from the data acquisition system and the computer.

Section 4 below discusses some signal conditioning circuits as they apply to particular sensors. The correct design of the signal conditioning system is critical in mapping the sensor output to the data acquisition input. Incorrect choices can affect the way the computer reacts to the human input. Thus, it is important to note the changes in the properties of the sensor signal caused by the conditioning circuitry.

2.3 Data Acquisition

The analog and continuous time signals measured by the sensor and modified by the signal conditioning circuitry must be converted into the form a computer can understand. This is what is referred to here as data acquisition. It should be clearly understood that this step is only necessary when interfacing human gestures to a digital computer. If, for example, one wanted to use the direction of eye gaze to control a wheelchair, no

data acquisition would be needed. The continuous analog voltages could be directly used to control the analog steering mechanism.

Section 5, however, deals specifically with the sampling and quantization techniques for using the information from the user to control a digital computer. The effects of such a process on the waveform received from the signal conditioning circuitry must be clearly understood in order to design the best possible computer controller for the given application.

3 Sensors

3.1 Piezoelectric Sensors

The Piezoelectric effect is an effect in which energy is converted between mechanical and electrical forms. It was discovered in the 1880's by the Curie brothers. Specifically, when a pressure (piezo means pressure in Greek) is applied to a polarized crystal, the resulting mechanical deformation results in an electrical charge. Piezoelectric microphones serve as a good example of this phenomenon. Microphones turn an acoustical pressure into a voltage. Alternatively, when an electrical charge is applied to a polarized crystal, the crystal undergoes a mechanical deformation which can in turn create an acoustical pressure. An example of this can be seen in piezoelectric speakers. (These are the cause of those annoying system beeps that are all too common in today's computers).

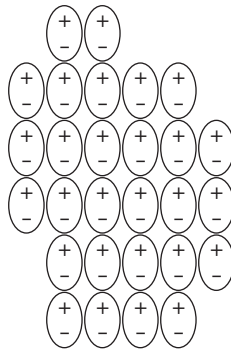

Figure 3: Internal Structure of an electret

Electrets are solids which have a permanent electrical polarization. (These are basically the electrical analogs of magnets, which exhibit a permanent magnetic polarization). Figure 3 shows a diagram of the internal structure of a electret. In general, the alignment of the internal electric dipoles would result in a charge which would be observable on the surface of the solid. In practice, this small charge is quickly dissipated by free charges from the surrounding atmosphere which are attracted by the surface charges. Electrets are commonly used in microphones.

Permanent polarization as in the case of the electrets is also observed in crystals. In these structures, each cell of the crystal has an electric dipole, and the cells are oriented such that the electric dipoles are aligned. Again, this results in excess surface charge which attracts free charges from the surrounding atmosphere making the crystal electrically neutral. If a sufficient force is applied to the piezoelectric crystal, a deformation will take place. This deformation disrupts the orientation of the electrical dipoles and creates a situation in which the charge is not completely canceled. This results in a temporary excess of surface charge, which subsequently is manifested as a voltage which is developed across the crystal.

In order to utilize this physical principle to make a sensor to measure force, we must be able to measure the surface charge on the crystal. Figure 4 shows a common method of using a piezoelectric crystal to make a force

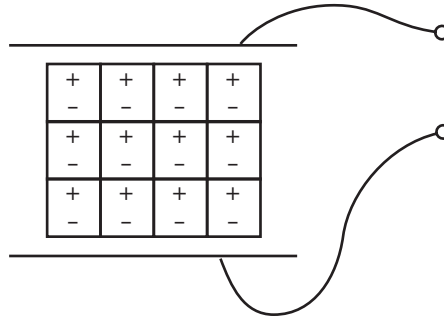

Figure 4: A sensor based on the piezoelectric effect

sensor. Two metal plates are used to sandwich the crystal making a capacitor. As mentioned previously, an external force cause a deformation of the crystal results in a charge which is a function of the applied force. In its operating region, a greater force will result in more surface charge. This charge results in a voltage $V = \frac{Q_f}{C}$, where Q_f is the charge resulting from a force f , and C is the capacitance of the device.

In the manner described above, piezoelectric crystals act as transducers which turn force, or mechanical stress into electrical charge which in turn can be converted into a voltage. Alternatively, if one was to apply a voltage to the plates of the system described above, the resultant electric field would cause the internal electric dipoles to re-align which would cause a deformation of the material. An example of this is the fact that piezoelectric transducers find use both as speakers (voltage to mechanical) and microphones (mechanical to electrical).

3.2 Force Sensing Resistors

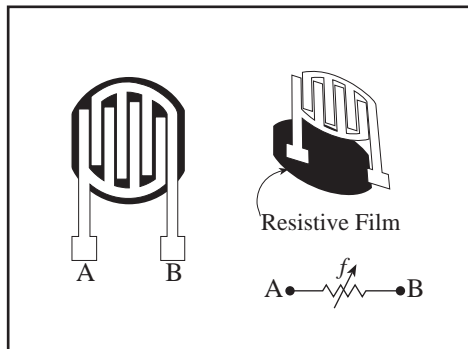

Figure 5: Diagram of a typical force sensing resistor

As their name implies, force sensing resistors use the electrical property of resistance to measure the force (or pressure) applied to a sensor. A force sensing resistor is made up of two parts. The first is a resistive material applied to a film. The second is a set of digitating contacts applied to another film. Figure 5 shows this configuration. The resistive material serves to make an electrical path between the two sets of conductors on the other film. When a force is applied to this sensor, a better connection is made between the contacts, hence the conductivity is increased. Over a wide range of forces, it turns out that the conductivity is approximately a linear function of force ($F \propto C, F \propto \frac{1}{R}$). Figure 6 shows the resistance of the sensor as a function of force. It is important to note the three regions of operation of the sensor. The first is the abrupt transition which occurs somewhere in the vicinity of 10 grams of force. In this region the resistance changes very rapidly. This behavior is useful when one is designing switches using FSRs. Above this region, the force is approximately

proportional to $\frac{1}{R}$ until a saturation region is reached. When forces reach this magnitude, additional forces do not decrease the resistance substantially.

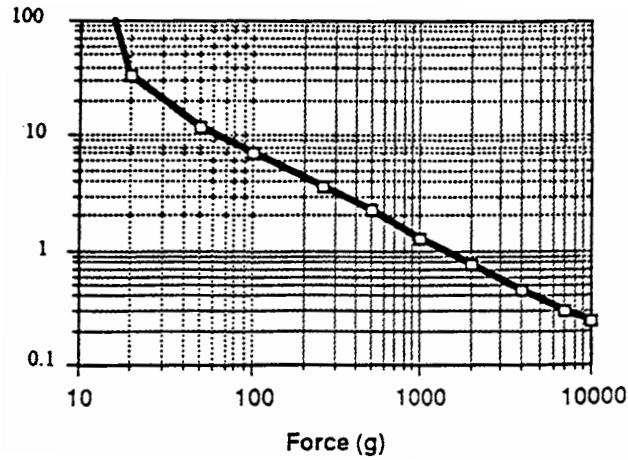

Figure 6: Resistance as a function of force for a typical force sensing resistor

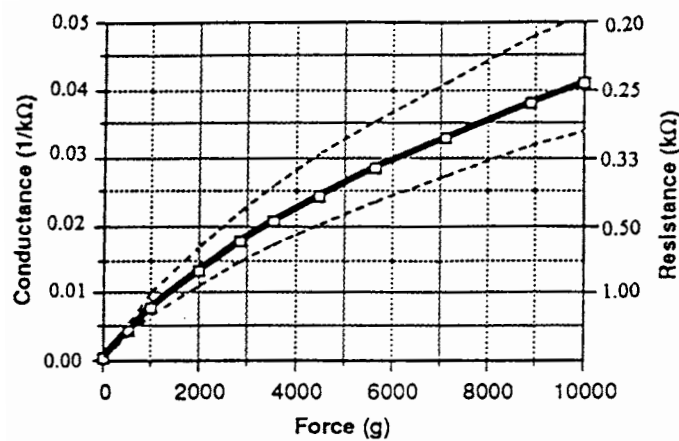

Figure 7: Conductance as a function of force for a typical force sensing resistor

Figure 7 shows a plot of conductance versus force for a typical FSR sensor. Notice that the x-axis is now a linear axis, and that above the break-point, conductance is approximately linear with force. It is important to make note of the fact that FSRs are not appropriate for accurate measurements of force due to the fact that parts might exhibit as much as 15% to 25% variation between each other.

3.3 Accelerometer (Analog Devices ADXL50)

The basic physical principle behind this accelerometer (as well as many others), is that of a simple mass spring system. Springs (within their linear region) are governed by a physical principle known as Hooke's law. Hooke's law states that a spring will exhibit a restoring force which is proportional to the amount it has been stretched or compressed. Specifically, $F = kx$, where k is the constant of proportionality between displacement (x) and force (F). The other important physical principle is that of Newton's second law of motion

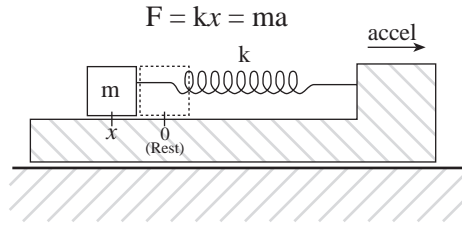

Figure 8: Mass-Spring system used for measuring acceleration

which states that a force operating on a mass which is accelerated will exhibit a force with a magnitude $F = ma$. Figure 8 shows a mass connected to a spring. If this system undergoes an acceleration, then by Newton's law, there will be a resultant force equal to ma . This force causes the mass to either compress or expand the spring under the constraint that $F = ma = kx$. Hence an acceleration a will cause the mass to be displaced by $x = \frac{ma}{k}$ or alternatively, if we observe a displacement of x , we know that the mass has undergone an acceleration of $a = \frac{kx}{m}$. In this way we have turned the problem of measuring acceleration into one of measuring the displacement of a mass connected to a spring. Note that this system only responds to accelerations along the length of the spring. This is said to be a single axis accelerometer. In order to measure multiple axes of acceleration, this system needs to be duplicated along each of the required axes.

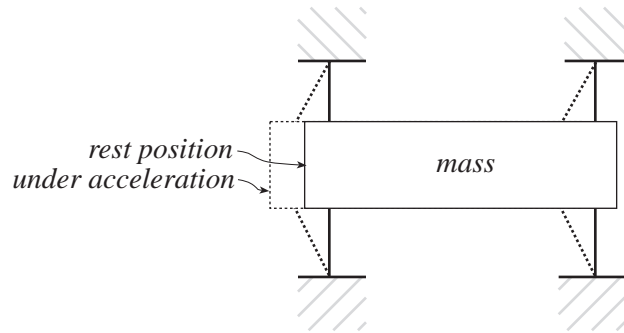

Figure 9: Mass-spring system used in the Analog Devices ADXL50 accelerometer

The Analog Devices ADXL50 is a micro-machined stand-alone accelerometer which consists of a mass spring system as well as a system to measure displacement and the appropriate signal conditioning circuitry (which is the topic of the next section). The mass spring system used in this device is depicted in Figure 9. The mass is a bar of silicon, and the spring system is implemented by the 4 tethers which attach to each corner of the mass. It responds to accelerations that occur in line with the length of the mass. When an acceleration occurs, the mass moves with respect to the anchored ends of the tethers. Roughly speaking, the amount of acceleration is proportional to the amount of displacement of the mass. This is not quite true in this case since the spring system is not an *ideal* spring as presented earlier. This fact is compensated for by some sophisticated signal conditioning circuitry present in the device.

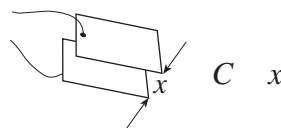

Figure 10: A simple capacitor

The next problem which needs to be solved is that of measuring the displacement of the bar. The principle

upon which this is based is that of the electrical property of capacitance. Capacitors are electrical components which store charge. A simple capacitor is formed by placing two metal plates in parallel with each other as shown in Figure 10. The amount of capacitance that a device such as this would exhibit is given by $C = \frac{k}{x_0}$, where k is a property of the material between the two plates. Using this, if one knew k and could measure capacitance, they would be able to determine x_0 , the spacing between the plates.

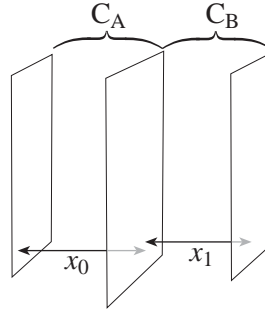

Figure 11: The dual Capacitor system used to measure displacement in the Analog Devices ADXL50 accelerometer

The ADXL50 takes this technique one step further and uses two capacitors configured as in Figure 11. If the device is at rest, and the spacing between each of the plates is x_0 , then each of the capacitors exhibits a capacitance of $C = \frac{k}{x_0}$. If the middle plate is moved by a distance x , then this results in:

$$C_A = \frac{k}{x_0 + x}$$

$$C_B = \frac{k}{x_0 - x}$$

This can then be written as:

$$C_A = C \frac{x_0}{x_0 + x}$$

$$C_B = C \frac{x_0}{x_0 - x}$$

The ADXL50 measures the difference between the two capacitors which is given by:

$$DC = C_A - C_B = Cx_0 \left[\frac{1}{x_0 + x} - \frac{1}{x_0 - x} \right] = \frac{-2x}{x^2 - x_0^2}$$

For small values of displacement x , the above expression reduces to:

$$DC \approx \frac{-2}{x_0^2} x$$

Hence the difference in capacitance is proportional to x , but only for small values of displacement. The ADXL50 uses a negative feedback control loop to make sure that the movement of the mass is kept small so that the above expression remains correct. Figure 12 shows a block diagram of the entire system.

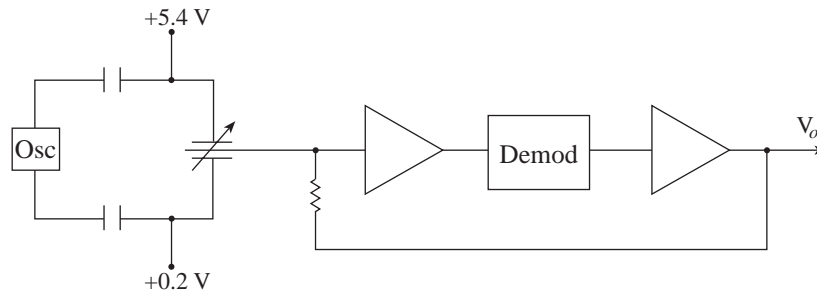

Figure 12: Block diagram of the Analog Devices ADXL50 accelerometer

3.4 Biopotential Sensors

The human body's nervous system uses the ebb and flow of ions to communicate. This ionic transport within and along the nerve fibers can be measured on the surface of the skin using a specific type of electrochemical sensor commonly referred to as the surface recording electrode (sometimes just called the electrode). A good reference on understanding the operation of the electrode can be found in Medical Instrumentation by Webster, 1992.

The purpose of the electrode is to act as a transducer between the ionic transport of the nerve and the electron flow in copper wire. It is the junction between the electrode and the electrolyte that allows such a transduction to take place (see Figure 13). The flow of ions in the electrolyte give rise to a flow of electrons (current) in the electrode due to an oxidation or reduction reaction (depending on the direction of current flow) occurring at the interface. What this means, using the example shown in Figure 13, is that anions in the electrolyte will flow to the interface boundary. Cations in the electrolyte will flow away from the interface boundary. To counteract this, electrons in the electrode will flow away from the interface boundary creating a current in the electrode. This process is called oxidation of the metal, C .

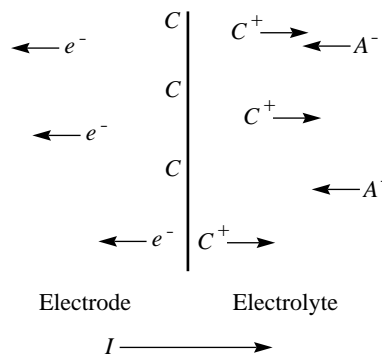

Figure 13: The Electrode - Electrolyte Interface

One of the most common types of electrodes is the Ag-AgCl electrode with an electrolyte containing Cl^- . There are two properties that make it a good choice for an electrode. First, it is practically non-polarizable, meaning that current flows freely across the electrode junction. (A polarizable electrode is one in which current does not flow across the electrode junction, thus causing the electrode to behave similarly to a capacitor.) Second, it generates less than 10uV of noise.

In common applications, the Ag-AgCl electrode with electrolyte gel is placed directly on the skin. Figure 14 shows the equivalent circuit for such an arrangement. The entire interface can simply be modeled for most

applications as an ideal voltage source with a DC offset and a series impedance. The DC offset is caused by the half cell potentials of the electrode-electrolyte and the electrolyte-skin interface. The impedance can range from 100's of ohms to several Mohms depending on the frequency of the biopotential being measured and preparation of the skin.

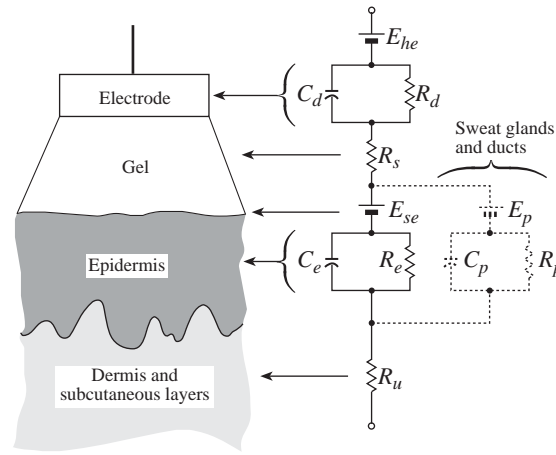

Figure 14: The equivalent circuit of an electrode placed on the skin

The surface recording electrode can be used to measure many different biopotentials. For, example, it can be used to measure electrical signals generated from the flexion and extension of the muscles. This signal is referred to as the electromyogram or EMG. This signal varies in frequency from approximately 50Hz to 1000Hz. Its amplitude varies from approximately 10uV to 1mV depending on properties such as the size of the muscle and the amount of exertion.

Another common signal measured by electrodes is the electroencephalogram or EEG. This is the signal caused by neural activity in the brain. It contains frequencies from less than 1 Hz up to 50Hz and amplitudes which are usually less than 10uV. Since the electrode is capable of picking up many other biopotentials in addition to the two mentioned here, its use as an input sensor for HCI is growing rapidly..

3.5 Microphones

Microphones are used to convert acoustical energy into electrical energy. The microphone serves as an example of the idea that a specific purpose can be accomplished using many different physical principles.

Carbon: Carbon microphones are made by encasing lightly packed carbon granules in an enclosure. Electrical contacts are placed on opposite sides of the enclosure. When an acoustical pressure is exerted on the carbon granules, the granules are pressed closer together which decreases the measured resistance. This is a very low quality acoustic transducer, but has been used in telephone handsets even through the current day.

Capacitor (condenser): Capacitor microphones are made by forming a capacitor between a stationary metal plate, and a light metallic diaphragm. When an acoustical pressure impinges on the diaphragm, the diaphragm moves and causes the distance between it and the stationary plate to change. As mentioned in a previous section, this will change the capacitance of the device. In order to measure the capacitance, one must apply a charge to the device. When this is done, the change in capacitance will result in a change in the voltage measured across the device since

Electret and Piezoelectric: Electret microphones are capacitor microphones which use an electret material between the plates of the capacitor. As mentioned earlier, electrets are materials with a permanent polarization, and hence surface charge. A benefit to using electret microphones is that they do not need any external circuitry to create the charge, and hence are much easier to use. Many high quality, low cost electret microphones are available currently.

As discussed previously, piezoelectric crystals are crystalline structures which are similar to electrets in that they exhibit a permanent polarization of the individual cells. It is possible to use piezo sensors as microphones as well. Since they are in the form of a thin film, they are very useful if one is interested in detecting surface vibrations of an object.

Magnetic (moving coil): Moving coil, or dynamic microphones are based upon the principle of magnetic induction. When an electrical conductor is moved through an electric field, a voltage is produced. This voltage is proportional to the velocity of the conductor. A moving coil microphone is made by attaching a coil of wire to a light diaphragm which moves in response to acoustical pressure. The coil of wire is immersed in a magnetic field, hence the movement of the coil in the magnetic field will create a voltage which is proportional to the acoustical pressure.

4 Signal Conditioning

4.1 Requirements for A-D converters

The primary purpose for the analog signal conditioning circuitry is to modify the sensor output into a form that can be optimally converted to a discrete time digital data stream by the data acquisition system. Some important input requirements of most data acquisition systems are:

1. The input signal must be a voltage waveform. The process of converting the sensor output to a voltage can also be used to reduce unwanted signals, i.e., noise.
2. The dynamic range of the input signal should be at or near the dynamic range of the data acquisition system (usually equal to the voltage reference level, V_{ref} , or $2*V_{ref}$). This is important in maximizing the resolution of the analog to digital converter (ADC).
3. The source impedance, R_s , of the input signal should be low enough so that changes in the input impedance, R_{in} , of the data acquisition system do not affect the input signal.
4. The bandwidth of the input signal must be limited to less than half of the sampling rate of the analog to digital conversion.

4.2 Additional Requirements for Signal Conditioning

There are many other uses for the signal conditioning circuitry depending on the particular HCI application. Some of these are:

Signal isolation In many applications it is necessary to isolate the sensor from the power supply of the computer. This is done in one of two ways: magnetic isolation or optical isolation. Magnetic isolation is primarily used for coupling power from the computer or the wall outlet to the sensor. This is done through the use of a transformer. Optical isolation is used for coupling the sensor signal to the data acquisition input. This is usually done through the use of a light emitting diode and a photodetector. This can be integrated into a single IC package such as the 6N139.

Signal preprocessing Many times it is desirable to perform preprocessing on the sensor signal before data acquisition. Depending on the application, this can help lower the required computer processing time, lower the necessary system sampling rate, or even perform functions that will enable the use of a much simpler data acquisition system entirely. For example, while an accelerometer system can output a voltage proportional to acceleration, it may be desired to only tell the computer when the acceleration is greater than a certain amount. This can be accomplished in the analog signal conditioning circuitry. Thus, the data acquisition system is reduced to only having a single binary input (no need for an ADC).

Removal of undesired signals Many sensors output signals that have many different components to them. It may be desirable or even necessary to remove such components before the signal is digitized. Additional other signals may corrupt the sensor output. This “noise” can also be removed using analog circuitry. For example, 60Hz interference can distort the output of low output sensors. The signal conditioning circuitry can remove this before it is amplified and digitized.

4.3 Voltage to Voltage

4.3.1 Motivation

Many sensors output a voltage waveform. Thus no signal conditioning circuitry is needed to perform the conversion to a voltage. However, dynamic range modification, impedance transformation, and bandwidth reduction may all be necessary in the signal conditioning system depending on the amplitude and bandwidth of the signal and the impedance of the sensor. The circuits discussed in this section and in subsequent sections are treated as building blocks of a human-computer input system. Their defining equations for their operation are given without proof. For a more detailed description of how they work, see **Design with Operational Amplifiers and Analog Integrated Circuits**, Franco 1988 or **The Art of Electronics**, Horowitz and Hill 1989. It is especially important to review the analysis of ideal op-amp circuits.

4.3.2 Circuits: Amplifiers

Inverting

The most common circuit used for signal conditioning is the inverting amplifier circuit as shown in Figure 15. This amplifier was first used when op-amps only had one input, the inverting (-) input. The voltage gain of this amplifier is $-\frac{R_F}{R_I}$. Thus the level of sensor outputs can be matched to the level necessary for the data acquisition system. The input impedance is approximately R_I and the output impedance is nearly zero. Thus, this circuit provides impedance transformation between the sensor and the data acquisition system.

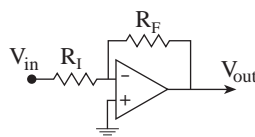

Figure 15: Inverting Amplifier

It is important to remember that the voltage swing of the output of the amplifier is limited by the amplifier’s power supply as shown in Figure 16. In this example, the power supply is +/- 13V. When the amplifier output exceeds this level, the output is “clipped”.

Just as the dynamic range of the amplifier is limited, so too is the bandwidth. Op-amps have a fixed gain-bandwidth product which is specified by the manufacturer. If , for example, the op-amp is specified to have a 3MHz gain-bandwidth product, and it is connected to have a gain of 100, this means that the bandwidth of

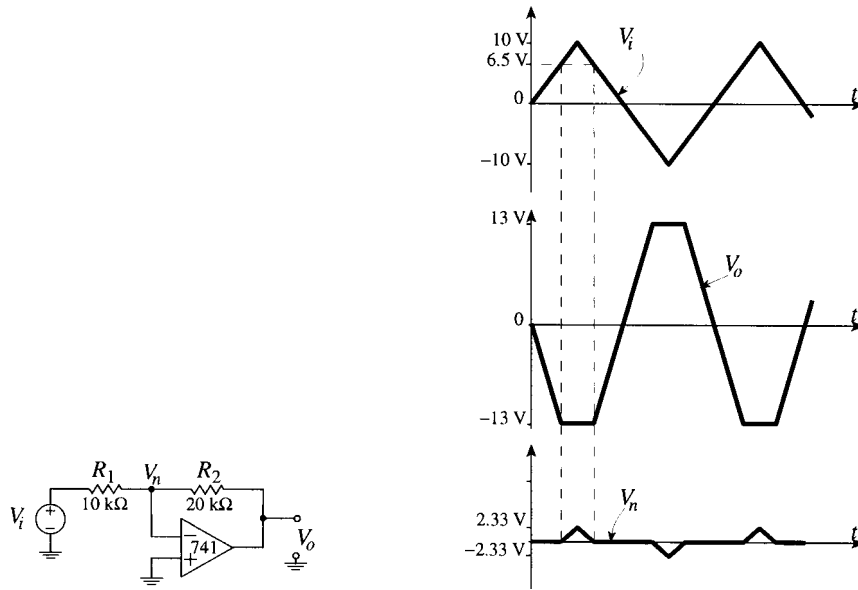

Figure 16: Clipping of an Amplifier's Output

the amplifier will be limited to 30kHz ($100 * 30\text{kHz} = 3\text{MHz}$). Another important limitation of the amplifier circuit is noise. All op-amps introduce noise to the signal. The amount and characteristics of the noise are specified by the manufacturer of the op-amp. Also, the resistors introduce noise. The equation for this thermal noise is $V_{\text{noise}}^2 = 4kTBR$; where k is Boltzmann's constant, T is the temperature, B is the bandwidth of the measurement device, and R is the value of the resistance. The main point to remember, is the larger the resistor values used, the larger the amount of noise introduced. One more limitation of the op-amp is offset voltage. All op-amps have a small amount of voltage present between the inverting and non-inverting terminals. This DC potential is then amplified just as if it was part of the signal from the sensor. There are many other limitations of the amplifier circuit that are important for the HCI designer to be aware. Too many, in fact, to describe in detail here (refer to the previously mentioned references.)

Non-Inverting

Another commonly used amplifier configuration is shown in Figure 17. The gain of this circuit is given as $1 + \frac{R_1}{R_2}$. The input impedance is nearly infinite (limited only by the op-amp's input impedance) and the output impedance is nearly zero. The circuit is ideal for sensors that have a high source impedance and thus would be affected by the current draw of the data acquisition system.

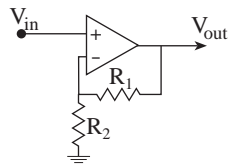

Figure 17: Non-Inverting Amplifier

If $R_1 = 0$ and R_2 is open (removed), then the gain of the non-inverting amplifier is unity. This circuit, as shown in Figure 18 is commonly referred to as a unity-gain buffer or simply a buffer.

Summing and Subtracting

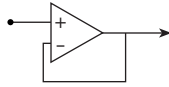

Figure 18: Unity-Gain Buffer

The op-amp can be used to add two or more signals together as shown in Figure 19.

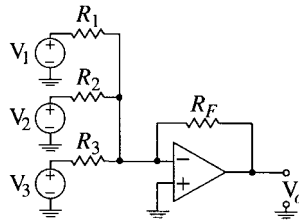

Figure 19: The Summing Amplifier

The output of this circuit is $V_{out} = V_1 * \frac{R_F}{R_1} + V_2 * \frac{R_F}{R_2} + V_3 * \frac{R_F}{R_3}$. This circuit can be used to combine the outputs of many sensors such as a microphone array. The op-amp can also be used to subtract two signals as shown in Figure 20. This circuit is commonly used to remove unwanted DC offset. It can also be used to remove differences in the ground potential of the sensor and the ground potential of the data acquisition circuitry (so-called ground loops).

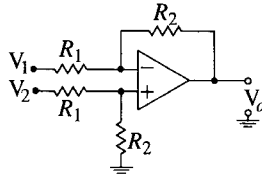

Figure 20: Difference Amplifier

The output of this circuit is given as $V_{out} = (V_2 - V_1) * \frac{R_2}{R_1}$. Thus V_2 can be the output of the sensor and V_1 can be the signal that is to be removed.

Instrumentation amplifier

Possibly the most important circuit configuration for amplifying sensor output is the instrumentation amplifier (IA). Franco defines the requirements for an IA as follows:

1. Finite, accurate and stable gain, usually between 1 and 1000.
2. Extremely high input impedance.
3. Extremely low output impedance
4. Extremely high CMRR.

CMRR (common mode rejection ratio) is defined as:

$$\text{CMRR} = \frac{A_{vd}}{A_{vc}}$$

Where:

$$A_{vd} = \frac{V_{out}}{V^+ - V^-} = \text{differential-mode gain}$$

$$A_{vc} = \frac{V_{out}}{\frac{V^+ + V^-}{2}} = \text{common-mode gain}$$

That is, CMRR is the ratio of the gain of the amplifier for differential-mode signals (signals that are different between the two inputs) to the gain of the amplifier for common-mode signals (signals that are the same at both inputs). The difference amplifier described above, clearly does not satisfy the second requirement of high input impedance. To solve this problem, a non-inverting amplifier is placed at each one of the inputs to the difference amplifier as shown in Figure 21. Remember that a non-inverting amplifier has a nearly infinite input impedance. Notice that instead of grounding the resistors, the two resistors are connected together to create one common resistor, R_G . The overall differential gain of the circuit is: $A_{vd} = (1 + 2\frac{R_3}{R_G})(\frac{R_2}{R_1})$

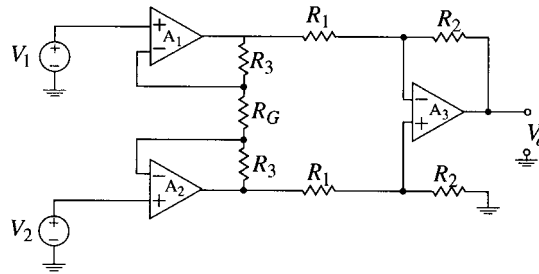

Figure 21: Instrumentation Amplifier

Lowpass and highpass filters

The non-inverting amplifier configuration can be modified to limit the bandwidth of the incoming signal. For example, the feedback resistor can be replaced with a resistor/capacitor combination as shown in Figure 22. Thus the gain of the circuit is now: $A_v = H_0 \frac{1}{1+j(\frac{f}{f_0})}$ where:

$$H_0 = -\frac{R_2}{R_1}, \text{ and}$$

$$f_0 = \frac{1}{2\pi R_2 C}$$

A filter “rolls off” at 20dB per 10-times increase in frequency (20dB/decade) times the order of the filter, i.e.: rate of attenuation = (order of filter) * (20dB/decade). Thus a first order filter “rolls off” at 20dB/decade as shown in Figure 23.

The input resistor of the inverting amplifier can also be replaced by a resistor/capacitor pair to create a high pass filter as shown in Figure 24. The gain of this filter is given by: $A_v = H_0 \frac{j(\frac{f}{f_0})}{1+j(\frac{f}{f_0})}$ where:

$$H_0 = -\frac{R_2}{R_1}, \text{ and}$$

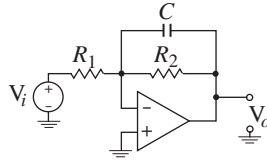

Figure 22: Single Pole Low-Pass Filter

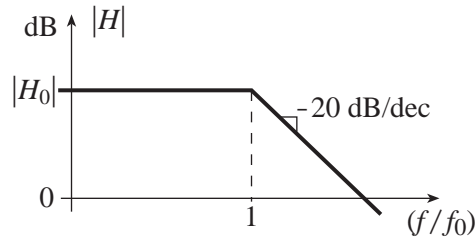

Figure 23: Frequency Response of Single Pole Lowpass Filter

$$f_0 = \frac{1}{2\pi R_1 C}$$

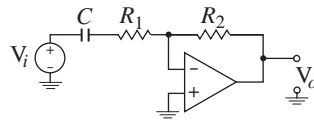

Figure 24: Single Pole High-Pass Filter

The frequency response of this filter is shown in Figure 25.

Higher order filters, which consequently have faster attenuation rates, can be created by cascading many first-order filters. Alternatively, the filter circuit can include more resistor/capacitor pairs to increase its order. The technique for doing this can be found in either of the references given previously. For the HCI designer, however, the two important steps are to determine the required filter order and to pick a circuit of that order - making sure that the circuit also meets any of the other previously described requirements of the signal conditioning circuitry.

4.3.3 Example: Piezoelectric Sensors

As mentioned previously, a common implementation practice is to sandwich a piezoelectric crystal between two metal plates. Figure 26 shows an equivalent electrical circuit of this arrangement. The voltage source represents the voltage that develops due to the excess surface charge on the crystal. The capacitor which appears in series is due to the capacitor formed by the metallic plates of the sensor. An important point to make is that piezo sensors cannot be used to measure a constant force, but rather is only useful for dynamic forces. If one is familiar with basic circuit theory, it should be clear that the capacitor blocks the direct current (the constant voltage resulting from a constant force).

In order to measure the force, one must measure the voltage which appears across the terminals of the sensor. It is impossible to measure voltage without drawing at least a little electrical current. This situation is summed

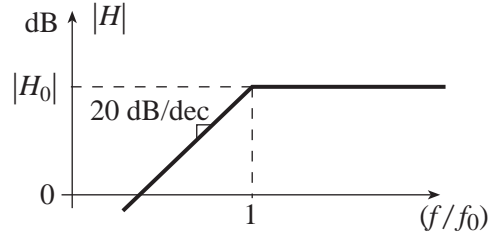

Figure 25: Frequency Response of a Single Pole High-Pass Filter

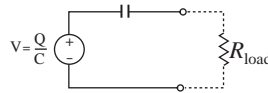

Figure 26: A piezoelectric sensor with a load resistance

up in Figure 26 where R_L represents the load impedance inherent in the measuring device. Figure 27 shows a typical response which might arise if a constant force is applied to the piezo. In the absence of a load resistance, a force applied to the crystal will develop a charge which will remain as long as the force is present. In the case where the load resistor is present, an electrical path is formed which serves to allow the charge to dissipate, which in turn reduces the voltage. The higher the value of the resistance, the longer it will take for the charge to dissipate. The *time-constant* of the system is defined as the time it takes the charge (or voltage) to decrease to approximately 37% its original value. The time constant τ is given by $\tau = RC$. Typical values for common piezo sensors is about 2.4nF (nano-farads), and typical input impedances for measuring devices is on the order of 10M Ω (mega-ohms). These values result in a τ of 24msec. Roughly speaking, this means that forces that are constant, or vary slowly will suffer from the fact that the voltage across the sensor will tend to decrease in amplitude, and the overall amplitude of the measure voltage will be reduced. Alternatively, forces which vary rapidly will not be subject to much if any decrease in amplitude.

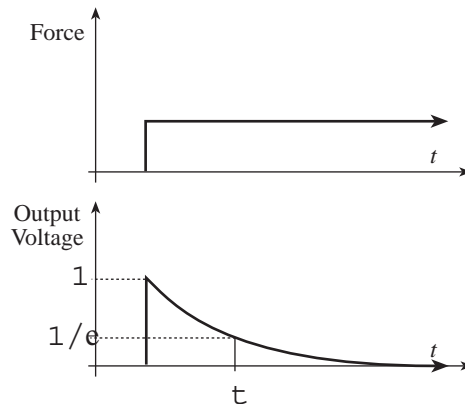

Figure 27: Time domain response of the output of a piezo sensor subject to a constant force

This situation can also be described in the *frequency domain*. In the time domain, the system is characterized by its time constant whereas in the frequency domain it is characterized by its cutoff frequency $f_c \triangleq \frac{1}{\tau}$. A plot of the frequency response of piezo sensor along with a load resistance is shown in Figure 28. For the sensor mentioned earlier with an internal capacitance of 2.4nF and a load resistance of 10M Ω , the cutoff frequency is equal to 6.6Hz. Specifically, this means that a force varying at a frequency of 6.6Hz will result in a measured

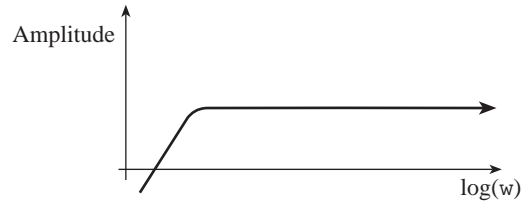

Figure 28: Frequency response of a piezo sensor

voltage which is 3dB less than a more rapidly varying force with the same amplitude. In many applications it is important to make the 3dB frequency as low as possible. In order to do this one must make the input impedance of their measuring circuit as high as possible. Thus a non-inverting amplifier is connected to the piezo output as shown in Figure 29.

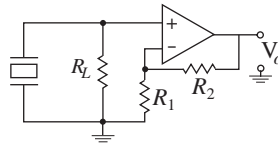

Figure 29: Amplified piezo sensor

Hence the circuit amplifies the voltage by the factor $1 + \frac{R_1}{R_2}$. The 3dB cutoff frequency of this circuit is $f_{cut} = \frac{1}{2\pi RC}$, where C is the internal capacitance of the sensor. It is clear that an increase in the value of the input resistor will result in a decrease in the cutoff frequency.

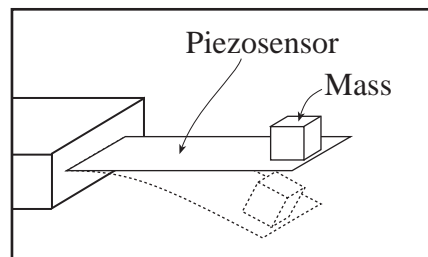

Figure 30: Using a piezoelectric sensor as an accelerometer

As mentioned several times, piezo sensors find many applications. Figure 30 shows a mechanical system which implements an accelerometer. In this system, a mass is placed on the tip of a piezo sensor forming a cantilever beam. When the mass undergoes an acceleration, a resultant force will cause the piezo film to bend, which will result in a voltage. Remember that the piezo sensor cannot measure a constant force, so this device can only measure dynamic acceleration, and cannot be used for applications such as tilt sensors.

4.4 Current to Voltage

4.4.1 Motivation

Some sensors output a current rather than a voltage. The most common sensor of this type is the photodiode which has a current output proportional to the amount of light shining on it. The purpose of the signal conditioning circuitry is to convert the current output of the sensor to a voltage.

4.4.2 Circuits

In converting a current to a voltage, one usually uses an inverting amplifier configuration, since a non-inverting amplifier draws very little current. Figure 31 shows a current amplifier connected to a photodiode. Notice that the circuit is identical to the non-inverting amplifier with the input resistor removed. As the light increases, the current output of the photodiode increases, increasing V_{out} proportionally: $V_{out} = I_s R$

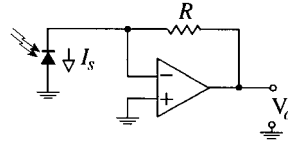

Figure 31: Photocell Connected to a Current Amplifier

4.5 Resistance to Voltage

4.5.1 Motivation

Many sensors exhibit a change electrical resistance in response to the quantity that they are trying to measure. Some examples include force sensing resistors which decrease their resistance when a force is applied, thermistors which change resistance as a function of the temperature and carbon microphones which alter their resistance in response to changing acoustical pressure. In all these cases, one must be able to convert the resistance of the device into a usable voltage which can be read by the analog to digital converters. Following are some circuits which perform these measurements along with some examples of sensors that were described in previous sections.

4.5.2 Circuits

There are two ways to convert resistance of a sensor to a voltage. The first, and simplest way is to apply a voltage to a resistor divider network composed of a reference resistor and the sensor as shown in Figure 32.

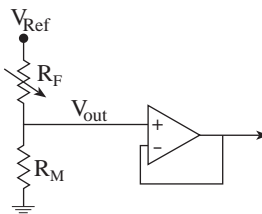

Figure 32: Resistance to Voltage

The voltage that appears across the sensor (or the reference resistor) is then buffered before being sent to the ADC. The output voltage is given by:

$$V_{out} = \frac{R_m}{R_m + R_f} = \frac{1}{1 + \frac{R_f}{R_m}}$$

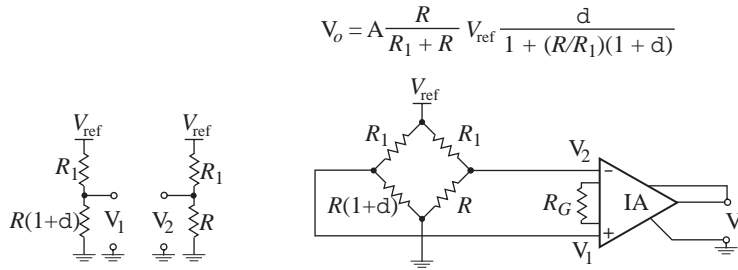

Figure 33: A Resistance Bridge Connected to an Instrumentation Amplifier (IA)

The problem with this method of measuring resistance is that the amplifier is amplifying the entire voltage measured across the sensor. It would be much better to amplify only the change in the voltage due to a change in the resistance of the sensor. This can be accomplished using a bridge as shown in Figure 33.

If R_1 is set equal to R , then the approximate output of this circuit is: $V_{out} = \frac{A}{4} V_{ref} d$ Where A is the gain of the IA and d is the change in the resistance of the sensor corresponding to some physical action. Notice in this equation that the gain can be set quite high because only the change in voltage caused by a change in the sensor resistance is being amplified.

4.5.3 Example

FSR

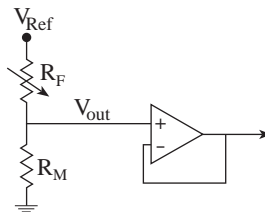

Figure 34: An FSR in a voltage divider configuration

The most basic method of interfacing to an FSR is depicted in Figure 34. In this configuration an FSR is used in a voltage divider configuration as described previously. In this case R_f from Figure 32 is the force sensing resistor. An increase in force results in a decrease in the value of R_f , and hence an increase in the output voltage. This configuration will not produce a voltage which is a linear function of force. If a linear characteristic is desired, then one must use a different configuration, or compensate for the actual response in software once the voltage data is acquired.

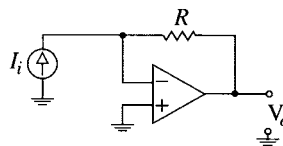

Figure 35: Measuring the current through an FSR

An alternative to the above implementation is to measure the current through the device, and then use an op-amp circuit to convert the current to a voltage. The current through the FSR is proportional to the conductance which is in turn proportional to the force, hence current is proportional to force. Moreover, within the appropriate region, this is a linear relationship. Figure 35 depicts an op-amp in a current to voltage configuration. What is shown here is simply the output of the FSR connected to the inverting input of the inverting amplifier described previously. The output voltage, V_{out} is given by:

$$V_{\text{out}} = V_{\text{ref}} - \frac{R_G}{R_F}$$

Since $R_F \propto \frac{1}{F}$, V_{out} is linearly proportional to force. Since the non-inverting terminal of the op-amp is grounded, the inverting terminal is effectively at ground, hence the current through the FSR is given by $\frac{V_{\text{ref}}}{R_f}$, hence the above expression can be written as $V_{\text{out}} = R_G I$.

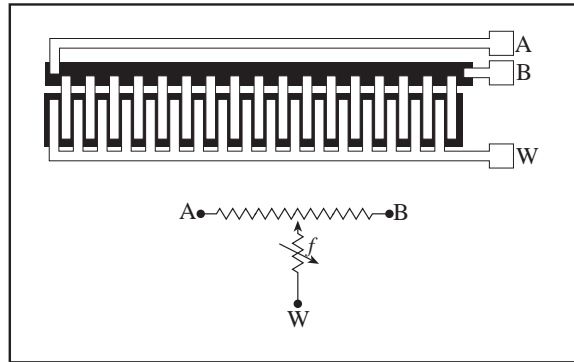

Figure 36: Linear potentiometer configuration of an FSR capable of measuring both force and position.

Standard FSRs are two terminal devices which measure force. Another configuration offered by Interlink is a three terminal linear potentiometer. Depending upon the circuitry it is hooked up to, this device can be used to measure either force or position. The physical layout of the device and a schematic representation of the device are given in Figure 36.

In order to understand how it measures the position of contact, first imagine that the force sensing resistive element is simply a wire. When pressure is exerted somewhere along the length of the device, contact is made. By measuring the amount of the resistance from either of the ends to one of the terminals one can determine the location at which the potentiometer has been pressed. One way to do this is to apply a voltage across the potentiometer. When the device is pressed, a connection is established which effectively creates a voltage divider. The voltage which appears at this terminal will be proportional to the position of contact. In our case, we do not have a wire, but rather a resistor, hence any current flowing through the resistor will cause a voltage drop. Furthermore, we cannot know the amount of the voltage drop since the resistance is unknown. One way around this dilemma is to sense the voltage while drawing as little current as possible. In order to do this, a buffer circuit, like the one described previously, is employed. This is summarized in Figure 37.

One way to measure the applied force is to apply a voltage to only one end of the potentiometer while leaving the other end open. Using the voltage divider circuit discussed earlier, one can measure the series combination of the force sensing resistive element and an unknown amount of resistance due to the section of the linear potentiometer. This circuit is shown in Figure 38. The amount of uncertainty can be reduced by tying both ends to the voltage supply. A more sophisticated approach is to implement a circuit that can switch between the two measurements schemes just discussed. Furthermore, if this is done fast enough, one can obtain both measurements almost simultaneously, and use the position measurement to compensate for the unknown resistance in the above scheme.

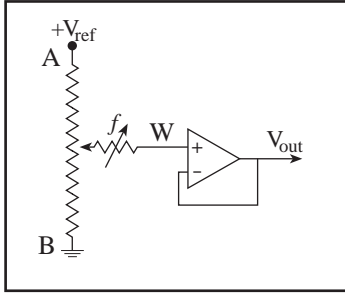

Figure 37: High input impedance measuring system used to measure position.

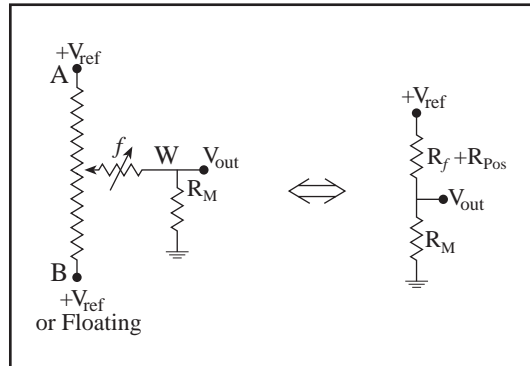

Figure 38: Circuit used to measure force with a linear FSR potentiometer.

4.6 Capacitance to Voltage

4.6.1 Motivation

We have seen that the electrical property of capacitance has been the main physical principle behind many of the sensors that we have discussed. The main reason why it is so useful is that it is a property which varies directly proportional to the distance between the metal plates. This has made it a useful tool in measuring small vibrations. Capacitance can also be used to measure much greater distances than we have seen so far. The Radio- Baton is an example of a system which uses capacitance to measure distances on the order of 1 meter.

Another useful property of capacitors is that they are sensitive to the material that resides between their metal plates. Specifically, it is the dielectric constant associated with the material that results in a change in capacitance. One example which makes use of this principle is that capacitors can be used as sensors which can detect the presence of an object between their plates. This principle can be used as a detector to determine when someone enters a space. In the case of the piezoelectric sensor, we used the fact that the voltage of a charged capacitor will vary inversely proportional to its capacitance. An op-amp circuit could then be used to amplify the voltage to a useable level. Since voltage and capacitance are inversely proportional, this is useful when small values of capacitance are to be measured. When one is dealing with larger values of capacitance the voltages resultant from a practical amount of charge are too small to be useful, and hence other methods must be used.

4.6.2 Circuits

Capacitance can be measured in the same two ways discussed previously for measuring resistance - a voltage divider or a bridge circuit. Instead of using resistors, capacitors are used. There is only one critical difference: V_{ref} must be a sinusoidal signal since the capacitor blocks DC. Since the impedance of a capacitor is inversely proportional to frequency, the HCI designer should choose a frequency for V_{ref} that creates a voltage across the capacitor that is appropriate for amplification (i.e, too small a frequency will cause too high of an impedance of the sensor which will cause too much noise from the sensor; too high of a frequency will cause too low of an impedance of the sensor which will cause other circuit noise to swamp out the voltage across the sensor).

4.6.3 Examples

ADXL50 Accelerometer

The ADXL50 accelerometer provides as its output a voltage level which varies in proportion to the amount of acceleration experienced along its sensitive axis. It is calibrated such that under no acceleration the output will be 1.8 volts. Furthermore, an acceleration of 50g (where 1g is the acceleration due to gravity) will cause a voltage swing of 1volt (ie. an acceleration of 50g would result in an output of either 2.8volts, or .8 volts depending upon the direction). In many cases this voltage swing would not be appropriate for a specific application, hence one must use a circuit which converts the output voltage into a more useful voltage range. For example, one might desire a more sensitive device which varied 1volt for every g of acceleration. Figure 39 depicts a circuit which accomplishes this task.

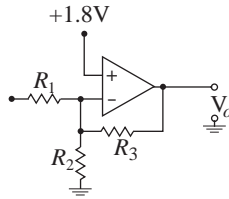

Figure 39: Schematic of an op-amp circuit which converts the output voltage of the ADXL-50 to a range which is suitable for analog-digital conversion.

The output voltage of this circuit is given by:

$$V_{out} = 1.8\left(\frac{R_2}{R_3} + 1\right) + \frac{R_2}{R_1}(1.8 - V_{in})$$

When no acceleration is applied to the device, the output voltage will be 1.8volts which makes the second term will be zero, and the output will be $1.8\left(\frac{R_2}{R_3} + 1\right)$, the new zero-g output. The output voltage can be written as:

$$V_{out} = (\text{zero-g output}) + \frac{R_2}{R_1} DV_{in}$$

where DV_{in} is the deviation of the output voltage from 1.8 volts. A 50g acceleration will result in DV_{in} of 1 volt, which will be scaled by $\frac{R_2}{R_1}$. In this way, we see that $\frac{R_2}{R_1}$ determines the sensitivity of the output, while the new zero-g output is determined by $1.8\left(\frac{R_2}{R_3} + 1\right)$.

4.7 Additional Signal Conditioning Circuits

4.7.1 Comparators

Sometimes there is no need to send the entire range of voltages from a sensor to the analog-to-digital converter (ADC). Instead, many times a sensor is used simply as a switch. Figure 40 contains a circuit called a *comparator* which takes an analog sensor voltage and compares it to a threshold voltage, V_{th} . If the sensor's voltage is greater than the threshold, the output of the circuit is maximum (typically 5V). If the sensor's output is less than the threshold, the output of the circuit is minimum (usually 0V). The threshold voltage is set by adjusting the potentiometer labeled R_{th} . The output of the sensor can also be reduced by using the resistor divider network as shown if desired. Notice that the circuit has a positive feedback resistor R_3 which assures that the output of the comparator will swing quickly and completely from maximum output to minimum output (also called "rail to rail").

Example - Using an FSR as a Switch

An example of when this might be useful is in the case of the force sensing resistor. As depicted in Figure 6, typical force sensing resistors exhibit a region in which the resistance varies rapidly in response to a rather small variation in force. The force which defines this knee' in the force vs. resistance curve is known as the break force. This behavior can be used to create a switch out of an FSR. This type of behaviour might be useful in devices such as membrane style keypads.

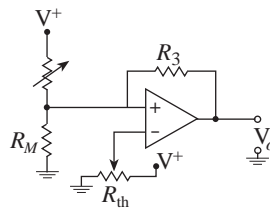

Figure 40: An FSR in a Switch Configuration, Using a Comparator

Figure 40 shows a circuit which implements a switch based upon a force sensing resistor. The variable resistor, R_{th} is used to set the sensitivity of the switch.

4.7.2 Signal Energy to Voltage

Motivation

Sometimes, even though a sensor's output is an extremely complex waveform, only the energy of the waveform is needed. This is accomplished by rectifying the waveform (taking the absolute value) and then smoothing (lowpass filtering) the result. This process is shown in the circuit below.

Notice that the output is a rectified version of the input. Figure 42 adds a couple capacitors to the above circuit to smooth the output.

Example - EMG Measurement Using an Electrode

As was discussed previously, the output of the electrode is a voltage waveform that measures underlying neural activity. Many times, when measuring the EMG, the complex waveform that is created by many neural motor units firing is irrelevant. What is of interest is the average energy caused by the muscle exertion. The circuit shown in Figure 42 is used to obtain this energy. The capacitors are usually chosen to smooth off changes faster than 5-10Hz.

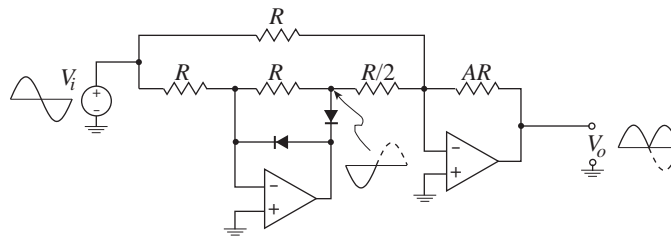

Figure 41: Energy to Voltage Conversion

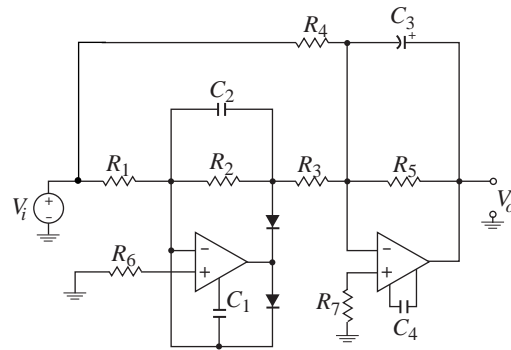

Figure 42: A Complete Energy Measurement Circuit